



NQ821B

User Manual



CD RECEIVER

YOUR CD RECEIVER

Dear Customer,

Congratulations on purchasing our Nakamichi mobile system product for your sound system.

This product has been designed and manufactured to Nakamichi's exacting standards to ensure many years of audio enjoyment. For the best performance, we recommend that you have your Nakamichi product installed by an authorized Nakamichi dealer.

If you would like to install this product on your own, we recommend for you to go through this manual to familiarize yourself with all the installation requirements and procedures.

If you encounter any issues or if you have any questions on the operation of this product, please contact your nearest authorized Nakamichi dealer for assistance, or you may also contact us through our website or social media channels.

Installation of your Product

In today's modern vehicles, it is very easy to cause damage to existing systems through improper installation. Please follow and scrutinize all wiring diagrams to ensure that you have connected everything in its proper place.

If you find yourself uncomfortable or unfamiliar with understanding the wiring and installation diagrams or testing instructions, do contact your nearest Nakamichi dealer to perform the installation for you.

Safety Warnings and Considerations

- Clean only with a dry cloth or other similar materials.
- Install your product in a dry, well-ventilated location that does not interfere with your vehicle's safety equipment.
- Do not block any ventilation openings when installing this product.
- Do not mount the product in the engine compartment of your vehicle or in any areas of extreme heat such as mufflers, silencers, exhaust pipes or other heat producing apparatus.
- Securely mount the product so that it does not come loose in the event of a collision or as a result of repeated vibrations that might occur during normal operation.
- Installation of the apparatus must be done with great care to prevent damage to your vehicle's fuel lines, power, and other electrical wiring, hydraulic brake lines, and other systems. If possible, always visit your nearest Nakamichi dealer to perform the installation.
- Do not run any wiring outside or underneath the vehicle. Keep all wires inside the vehicle.

YOUR CD RECEIVER

- Take the necessary precautions when making connections to the vehicle's battery to avoid any potential shock.
- Protect all system wires from sharp edges by carefully routing them, always use rubber grommets to protect wiring and cables whenever you are installing them through metal openings.
- Secure all wiring using cable ties or wire clamps to protect them from moving parts and sharp edges.
- This apparatus shall not be exposed to dripping or splashing, and no object filled with liquids, shall be placed on the apparatus.
- Refer all servicing to qualified service personnel. Servicing is required when the apparatus has been damaged in any way, such as the power input terminals are damaged, liquid has been spilled or objects have fallen into the apparatus, the apparatus has been exposed to rain or moisture, does not operate normally, or has been dropped.
- Fuses shall be replaced only with the correct type and fuse value, and only when the apparatus is powered off.
- Exposure to high sound pressure levels may lead to permanent hearing loss. Take every precaution to protect your hearing.
- This product is designed specifically for use with 12 volt, negative-ground electrical systems only. Using this product in systems with positive ground and/or voltages other than 12V may result in damage to the product and your system.

Warranty Considerations

Nakamichi warrants this product to be free of defects in materials and workmanship for **a period stated by your country's authorized Nakamichi distributor**. This warranty is not transferable and applies only to the original owner who has purchased from an authorized Nakamichi dealer or distributor.

Damage caused by the following is not covered under warranty: accident, misuse, abuse, product modification or neglect, failure to follow installation instructions, unauthorized repair attempts, misrepresentations by the seller.

This warranty does not cover incidental or consequential damages and does not cover the cost of removing or reinstalling the unit(s). Cosmetic damage due to accident or normal wear and tear is not covered under warranty.

Warranty is void if the product's serial number has been removed or defaced.

CONTENTS

INTRODUCTION.....	1 EN
ACCESSORY LIST.....	1 EN
DIMENSIONS.....	1 EN
OVERVIEW OF THE COMPONENTS.....	2 EN
Remove Panel	
Remote Control	
WIRING DIAGRAM.....	3 EN
GENERAL OPERATION.....	4 EN
Power On/Off	
Removing The Front Panel	
Volume Up And Down	
Mute On/Off	
Changing The Modes	
Setting The Audio/Menu	
Display	
Auxiliary Input Jack	
Reset	
RADIO OPERATION.....	5 EN
Switch Between Europe/USA/Asian/Russian Frequency	
Changing Bands	
To Store / Recall Preset Stations	
Manual Tuning	
Seek Tuning	
Automatic Store Preset Station	
CD/USB OPERATION.....	6-7 EN
Insert/Eject CD	
USB Connection	
Select Next Track Or Previous Track	
Fast Forward/Reverse	
Play/Pause	
Introduction Scan	
Repeating The Track	
Playing All Tracks In Random	
Folder/Track Navigation	
BLUETOOTH OPERATION.....	8-9 EN
Pair And Connect	
Make A Call	
Redial Last Dialed Number	
Answer A Call	
Reject A Call Or End A Call	
Switch Audio Between Car Audio And Mobile Phone	
Adjust Talk Volume	
Audio Streaming (A2DP)	
APP OPERATION.....	9 EN
SPECIFICATION.....	10 EN

ACCESSORY LIST

1. User Manual	1pc	2. CD Receiver	1pc
3. ISO Male Connector	2pcs	4. Metal Accessories	1set
5. Remote Control	1pc	6. Disassemble Tool	2pcs

Dimensions(Unit: mm)

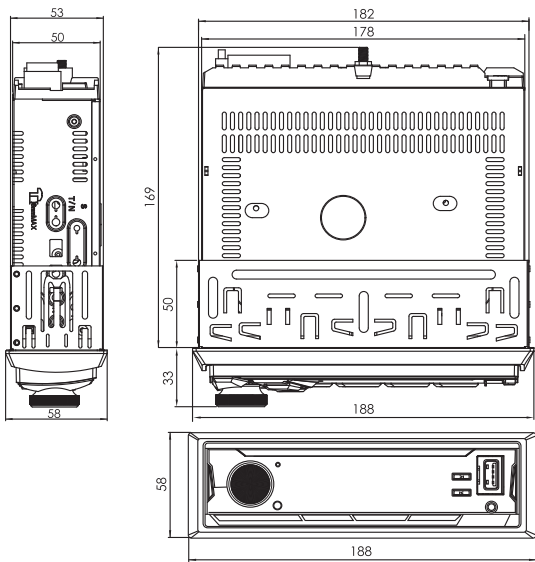

COMPONENTS

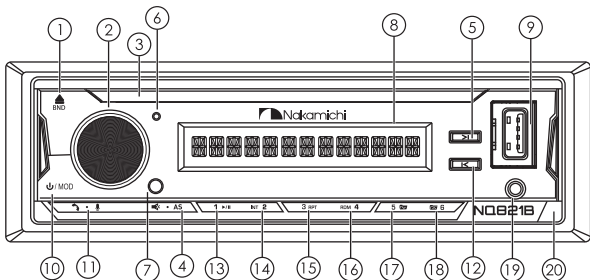

REMOVE PANEL

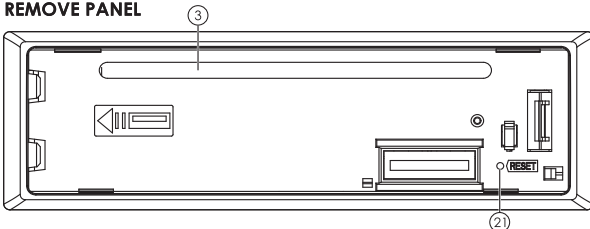

1. Eject CD, Band, Disp(Display clock time and other info.)
2. Volume knob, SEL(Push for Audio/Menu Setting)
3. Disc Slot
4. Mute, AS(Auto Store Preset Station)
5. Tune/Track Up, fast forward
6. Hands-free Microphone
7. IR Remote Sensor
8. LCD Display
9. USB Port
10. Power on/off, Mode(Source)
11. Answer Call, End Call(Long press)
12. Tune/Track down, reverse
13. Preset #1, Play/Pause
14. Preset #2, Intro Scan
15. Preset #3, Repeat
16. Preset #4, Random
17. Preset #5, Folder Down, Jump 10 Track backward
18. Preset #6, Folder Up, Jump 10 Track forward
19. Aux Input Socket
20. Release (For detach the front panel)
21. Reset

REMOTE CONTROL

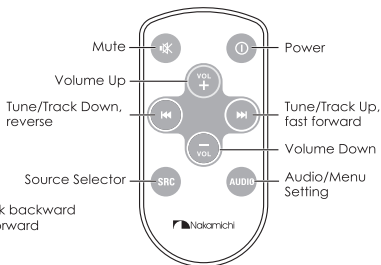

WIRING DIAGRAM

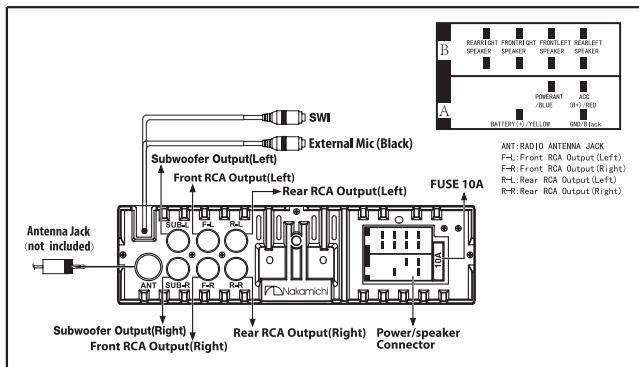

	Color	Function
A	Red	Lignition Cable
	Black	Ground Cable
	Blue	ANT Automatic
	Yellow	Power Supply
B	Green Green/Black	Rear Left Speaker(+) Rear Left Speaker(-)
	White White/Black	Front Left Speaker(+) Front Left Speaker(-)
	Grey Grey/Black	Front Right Speaker(+) Front Right Speaker(-)
	Violet Purple/Black	Rear Right Speaker(+) Rear Right Speaker(-)

GENERAL OPERATION

Power On/Off

- Press any button to turn the unit on.
- Press and hold the **⏻/MODE** button to turn the unit off.

Removing The Front Panel

Press the **RELEASE** button to detach the front panel.

Volume Up And Down

Rotate the **Volume** knob to adjust the volume level.

Mute On/Off

Briefly press the **⏻** button to toggle mute on or off.

Changing The Modes

Press the **⏻/MODE** to select between Radio, Disc, USB (with USB device inserted), AUX-IN (auxiliary input) and BT (Bluetooth) modes.

Setting The Audio/Menu

- Press **Volume (SEL)** button momentarily to select between the audio/menu functions: BASS, TREBLE, BALANCE, FADER, EQ USER/FLAT/CLASSIC/ROCK/POP, LOUD OFF/ON, BEEP OFF/ON, CLOCK 24/12, CLOCK SETTING, BT MENU/AUTO, DISTANT/LOCAL, STEREO/MONO, AREA EU/US/AS/RU.
- Rotate the **Volume** knob to adjust or activate your desired function /audio.

Display

- With the unit on, press and hold **DISP** to display clock time.
- Press and hold **DISP** to toggle display between various displayed information.

Auxiliary Input Jack

Using a 3.5mm cable to connect a external device such as MP3 players, CD players etc. to the auxiliary input jack on front panel. Then you can hear the sound of other playback devices such as MP3 players, CD players etc. through your car speakers.

Reset

Push the **RESET** button (behind the front panel) with a thin object with a pointed end to reset the unit back to the factory default settings.

RADIO OPERATION

Switch Between Europe /USA/Asian/Russian Frequency

In radio mode, press the **Volume** button momentarily to choose the "AREA EU/US/AS/RU" item, then rotate it to switch between EU(europe),US(USA), AS(Asian), RU(Russian) frequency. The system will change the frequency setting in about 3 seconds.

Change Bands

In radio mode, shortly press the **BAND/DISP** to select between the FM1, FM2, FM3 and AM1(MW1), AM2(MW2) bands.

To Store / Recall Preset Stations

The radio can be stored 6 preset stations for each band (FM1, FM2, FM3, AM1 and AM2) for a total of 30 preset stations.

- To memorize a station:

Press and hold the desired preset buttons (1-6) to save a radio station.

- To recall a preset station:

Briefly press the respective station button (1-6) to recall the corresponding preset station.

Manual Tuning

In the radio mode:

Briefly press the **>>I** or **I<<** button to search the next or previous frequency step by step.



Seek Tuning

In radio mode:

Press and hold the **>>I** or **I<<** button to seek to next or previous strong station.

Automatic Store Preset Station

Press and hold **AS** for more than 2 seconds to store 18 FM stations and 12 AM(MW) stations automatically.

Item	Selectable Setting
RDS On/Off	Shortly press the Volume button to choose the 'AREA EU' Station. The system will change to the frequency setting within 3 seconds.
PTY  (Program type)	Once into the PTY mode, press the  get into program type item, and rotate the volume knob to selected category. ■ Available Program Type: POP M; ROCK M; EASY M; LIGHT M; CLASSICS; OTHER M; JAZZ M; COUNTRY; NATION M; OLDIES M; FOLK M; A-TEST; ALARM; NEWS; AFFAIRS; INFO; SPORT; EDUCATE; DRAMA; CULTURE; SCIENCE; VARIED; WEATHER; FINANCE; CHILDREN; SOCIAL; RELIGION; PHONE IN; TRAVEL; LEISURE; DOCUMENT
AF (Alternate Frequencies)	■ ON: The unit will be searches for another station with stronger signal, but with the same program identification as the current station automatically. ■ OFF: Cancel
TA (Traffic Announcement)	■ ON: When there is traffic announcement, the unit switches to the tuner mode (regardless of the current mode) and begins to broadcast the announcement on traffic conditions. When the traffic announcement is over, it returns to the previous mode. ■ OFF: Traffic announcement does not cut in.

CD/USB OPERATION

Insert CD

With the label facing up, insert a standard size CD into the CD slot. Playback will begin automatically.

Eject CD

Press **▲** (Eject button) to eject the CD.

USB Connection

If you would like to playback files contained in a USB stick, please insert the stick into the USB port. The MP3/WMA and other music files will be played automatically.

Note: The USB port of this car radio is also designed for charging for iPhone/andriod mobile phone. The charging current consumption is 1 ampere.

Select Next Track Or Previous Track

In the CD/USB mode, briefly press the **>>|** or **|<<<** button to play the next or previous track.

Fast Forward/Reverse

Press and hold the **>>|** or **|<<<** button to fast forward or reverse a track.

Play / Pause

Press the **▶/||** button to interrupt the CD/USB playback (pause function). Press this button again to continue the playback.

Introduction Scan

Press **INT** to play the first 10 seconds of each track on CD/USB. Press again to cancel the INT function.

- INT ON - Plays the first 10 seconds of each track.
- INT OFF - Cancels the INT function.

Repeating The Track

Press **RPT** to toggle between RPT FLD, RPT ALL, and RPT ONE.

- RPT FLD - Continuously repeats all files in current folder.
- RPT ALL - Plays all tracks on CD/USB device.
- RPT ONE - Continuously repeats selected track.

Playing All Tracks In Random

Press **RDM** to play songs in random order, press again to cancel the RDM function.

CD/USB OPERATION

- RDM ON - Plays all tracks in random order.
- RDM OFF - Cancels the RDM function.

Folder/Track Navigation

- Press the  or  button to select the previous or the next folder. Folder access is only available on devices with more than one folder.
- Press and hold the  or  buttons to jump 10 tracks backward or forward. It is required that over 10 tracks be available on the storage medium.

BLUETOOTH OPERATION

Pair And Connect

Before using the Bluetooth device as a handsfree system for a Bluetooth enabled mobile phone for the first time, you must pair and connect the two devices as follows:

1. In any mode, prior to pairing and connecting, the BT logo on the LCD indicating that no device is connected. The head unit broadcasts the pairing signal constantly when no devices are connected. Activate the Bluetooth on your device before beginning the pairing process.
2. When your phone finds the car audio system, the "NQ821B" name will be displayed on your phone screen.
3. Choose the "NQ821B" from your mobile phone list to pair and connect with the car audio system. Upon confirming, the BT logo will stop flashing.
4. When pairing is complete, the mobile phone audio will automatically transfer to the car audio system whenever a call is made or received, or when the mobile phone plays music.

Note:

For more details of bluetooth pairing, please refer to the owner's manual for your mobile phone.

Make A Call

- To make a call, dial the call directly from the paired mobile phone.

Redial Last Dialed Number

Press and hold the  button to redial the last dialed phone number. Press the  button to activate SIRI function.

Answer A Call

- When the mobile phone is called, the incoming telephone number displays on the LCD display, press the  button to answer the incoming call.

Reject Or End A Call

Press the  button to reject, press and hold the  to end the call.

Switch Audio Between Car Audio And Mobile Phone

During a call, press the  button to switch the audio source from the car audio system back to your mobile phone.

BLUETOOTH OPERATION

Adjust Call Volume

- During a call, use **Volume** knob or **VOL+ /VOL-** button to adjust the call volume level.
- Use the **MUTE** button to mute sound.

Audio Streaming (A2DP)

The head unit supports A2DP wireless streaming audio from a Bluetooth mobile device directly to your head unit.

The following functions can be used to control the music:

- Press the **>>|** button to skip to the next available audio track.
- Press the **|<<** button to skip to the previous audio track.
- Press the **▶/||** button to toggle between play and pause during music playback.

APP OPERATION

Using the application from NAKAMICHI, you can wireless remote control the car audio of NQ821B head unit with Apple & Android devices.

Please go to the APPLE APP Store or Google Play Store and search NAKAMICHI app, after downloading the APP, install it on your Apple & Android devices.



Connect your smartphone to NQ821B through bluetooth, then tap the APP and turn on it on your smartphone.

Now you can control the audio and the RDS function (Optional) of NQ821B head unit by your smartphone.

SPECIFICATIONS

GENERAL

Power Supply Requirement :	DC 12V
Maximum Power Output :	50W X 4CH
Speaker Impedance :	4 - 8 Ohm
Unit Dimensions(WxHxD) :	178 X 160 X 50 mm
Weight:	1.3 kg
Fuse :	10 A

RADIO

FM

Frequency Range:	87.5 MHz - 107.9 MHz (USA) 87.5 MHz - 108.0MHz (EUROPE)
Channel Step:	200 KHz(USA) 50 KHz(EUROPE)

AM

Frequency Range:	530 KHz - 1710 KHz (USA) 522-1620 KHz(EUROPE)
Channel Step:	10 KHz(USA) 9 KHz(EUROPE)

CD/USB

Usable Audio Formats:	CD/MP3/WMA
USB Port Type:	2.0
USB Charging:	5V/1A
Frequency Response:	20 Hz - 20KHz
S/N Ratio:	60dB

BT

Supported Bluetooth Profiles:	A2DP, AVRCP, HFP
Frequency Range:	2.4GHz spectrum

FCC WARNING

This device complies with Part 15 of the FCC Rules. Operation is subject to the following two conditions: (1) this device may not cause harmful interference, and (2) this device must accept any interference received, including interference that may cause undesired operation.

PRECAUTIONS ON POWER SUPPLY AND SPEAKER CONNECTIONS:

Do not connect the speaker leads of the power cord to the car battery; otherwise, the unit will be seriously damaged.

BEFORE connecting the speaker leads of the power cord to the speakers, check the speaker wiring in your car.

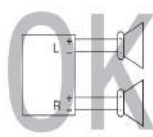
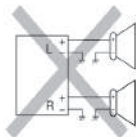
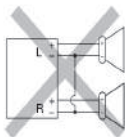

目錄

引言.....	1 CN
附件清單.....	1 CN
產品尺寸.....	1 CN
面板組件概述.....	2 CN
取掉面板後主機前端示意圖	
遙控器按鍵功能描述	
接綫圖.....	3 CN
基本功能操作.....	4 CN
開啟/關閉主機電源	
取下主機面板	
音量調節	
靜音開關	
模式轉換	
音頻/菜單設置	
顯示屏信息顯示	
AUX外接音頻輸入接口	
復位鈕	
收聽廣播電臺.....	5 CN
預設收聽歐洲/美國/亞洲/俄羅斯地區的廣播電臺	
廣播電臺波段選擇	
手動存儲/調用預置的廣播電臺	
手動調諧電臺頻率	
自動調諧電臺頻率	
自動存儲預置廣播電臺	
播放CD光碟和USB閃存設備內的音樂.....	6-7 CN
插入/退出CD光碟	
將USB閃存設備插入主機面板上的USB接口	
選擇播放下一首或上一首歌曲	
歌曲快進或歌曲快退	
音樂播放/暫停播放	
歌曲前10秒預覽	
重復播放模式選擇	
隨機播放歌曲	
選擇上一個或下一個文件夾/選擇上10首或下10首歌曲	
藍牙免提操作.....	8-9 CN
藍牙配對和藍牙連接	
撥打電話	
重撥最後撥打過的電話號碼	
接聽來電	
拒絕接聽來電或終止通話	
選擇手機通話或藍牙免提通話	
調節通話音量	
藍牙音樂播放(A2DP)	
通過手機APP控制主機音頻.....	9 CN
性能指標.....	10 CN

引言

感謝購買Nakamichi產品！为了更好的獲得我們的售後服務，請認填寫并保留好發票。最好能把發票副本寄回給我們指定的服務代理商，這樣你就可以獲得更多的技術支持。

附件清單

1. 用戶使用說明書	1本	2. 主機	1臺
3. ISO連接器(公插)	2個	4. 五金附件	1個
5. 遙控器	1個	6. 鑰匙片	2個

產品尺寸(單位: mm)

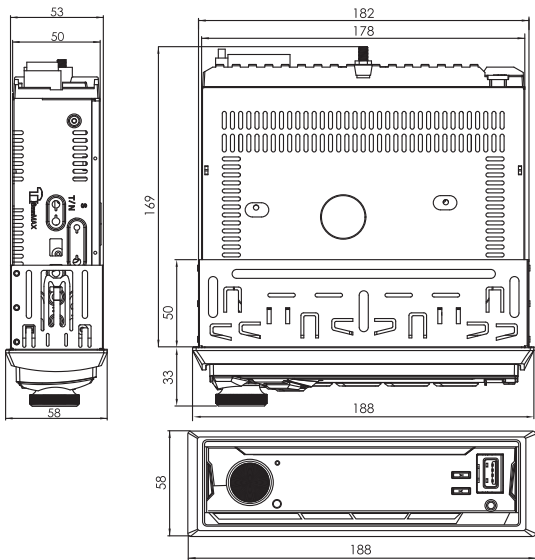

面板組件概述

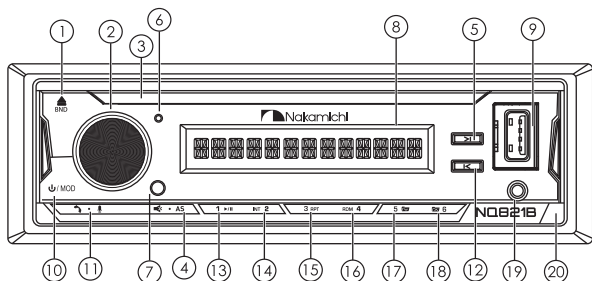

去掉面板後主機前端示意圖

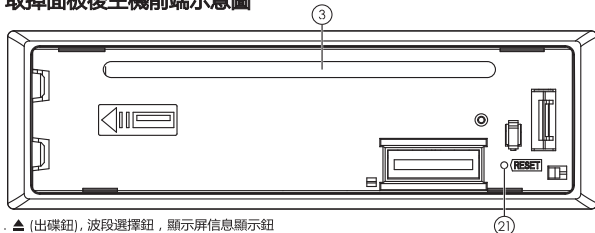

1. ▲ (出碟鈕), 波段選擇鈕, 顯示屏信息顯示鈕
2. 音量旋鈕, SEL鈕(短按進入音頻/菜單設置模式)
3. CD碟片出入口
4. 靜音鈕, AS鈕(自動存儲預置廣播電臺)
5. 遞增調諧電臺頻率/選擇后一首歌曲, 快進鍵
6. 內置藍牙麥孔
7. 紅外遙控接收器
8. 液晶顯示屏
9. USB閃存接口
10. 電源開關, 模式選擇鈕
11. 接聽電話, 終止通話(長按)
12. 遞減調諧電臺頻率/選擇前一首歌曲, 快退鍵
13. 預置電臺 #1, 音樂播放/暫停播放
14. 預置電臺 #2, 歌曲前10秒預覽
15. 預置電臺 #3, 重複播放模式選擇
16. 預置電臺 #4, 隨機播放歌曲
17. 預置電臺 #5, 上一個文件夾, 上10首歌曲(長按)
18. 預置電臺 #6, 下一個文件夾, 下10首歌曲(長按)
19. AUX外接音頻輸入接口
20. 面板釋放鈕(用于取出面板)
21. 復位鈕

遙控器按鍵功能描述

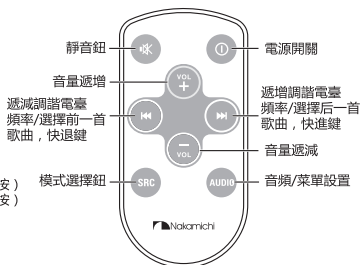

接綫圖

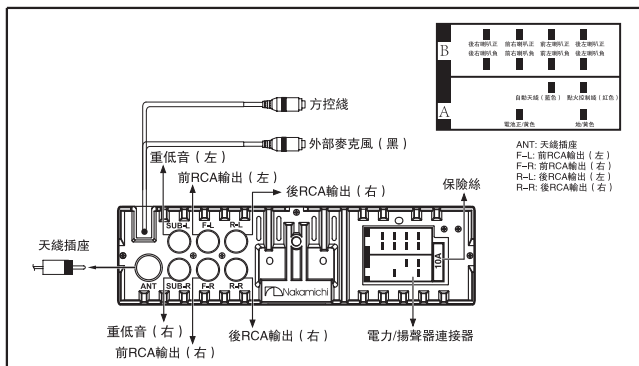

	顏色	功能
A	紅色	ACC 綫
	黑色	地綫
	藍色	ANT天綫
	黃色	電源綫
B	綠色 綠色/黑色	左後喇叭 (+) 左後喇叭 (-)
	白色 白色/黑色	前左喇叭 (+) 前左喇叭 (-)
	灰色 灰色/黑色	前右喇叭 (+) 前右喇叭 (-)
	紫色 紫色/黑色	後右喇叭 (+) 後右喇叭 (-)

基本功能操作

開啟/關閉主機電源

- 短按面板任意按鈕（面板釋放鈕除外）開啟主機電源。
- 長按面板  /MODE鈕關閉主機電源。

取下主機面板

短按面板釋放鈕，彈出面板，可將面板從主機上取出妥善保管。

音量調節

旋轉音量鈕調節主機音量大小。

靜音開關

短按面板上的  鈕開啟用或停用靜音功能。

模式轉換

短按  /MODE鈕選擇收音廣播, CD光碟, USB閃存(USB閃存設備已插入), AUX-IN(外接音頻輸入)和藍牙模式(藍牙免提或藍牙音樂模式)。

音頻/菜單設置

- 反復短按音量鈕選擇可按以下順序選擇設置本機音頻/菜單功能: 低音(BAS), 高音(TRE), 左右聲道平衡(BAL), 前後聲道衰減(FAD), 均衡器音效預設用戶自定義(USER)/平音(FLAT)/古典(CLASSIC)/搖滾(ROCK)/流行(POP), 等響度開關(LOUD OFF/ON), 按鍵蜂鳴聲開關(BEEP OFF/ON), 24/12小時制式(CLOCK 24/12), 小時分鐘設置, 藍牙免提電話手動接聽/自動接聽(BT MENU/AUTO), 收聽遠程廣播電臺/收聽本地廣播電臺(DISTANT/LOCAL), 立體聲/單聲道模式(STEREO/MONO), 收聽歐洲/美國/亞洲/俄羅斯地區的廣播電臺(AREA EU/US/AS/RU)。
- 旋轉音量鈕可調節或設置當前選擇的音頻/功能。

顯示屏信息顯示

- 開機后, 長按DISP鈕在顯示屏上顯示小時和分鐘。
- 長按DISP鈕轉換顯示屏上的顯示信息(電臺頻率, 時間, 音樂播放等信息)。

AUX外接音頻輸入接口

使用一根3.5mm音頻轉接線, 可將我們常用的MP3播放器, CD播放樂連接到主機面板的AUX外接音頻輸入接口。這樣, 我們就能通過本機和車載喇叭來聽外接的MP3播放器, CD播放器音樂。

復位鈕

取下面板後, 用帶尖頭的細小物體按主機基座上RESET鈕將機子恢復到出廠初始設置。

收聽廣播電臺

預設收聽歐洲/美國/亞洲/俄羅斯地區的廣播電臺

在收音廣播模式，短按音量鈕選擇收聽歐洲(AREA EU)，美國(AREA US)，亞洲(AREA AS)或者俄羅斯(AREA RU)地區的廣播電臺。

選中某一地區後，3秒鐘內，本收音系統將轉換到相應地區的電臺頻率。

廣播電臺波段選擇

在收音廣播模式，短按BAND/DISP鈕選擇以下任一廣播波段：FM1, FM2, FM3 和 AM1(MW1), AM2(MW2)。

手動存儲/調用預置的廣播電臺

此收音系統每個波段可存儲6個預置電臺，FM1, FM2, FM3, AM1(MW1), AM2(MW2)總計可存儲30個預置廣播電臺。

- 手動存儲預置廣播電臺：

長按想要存儲的預置電臺數字鍵 (1~6)，可將當前頻率存儲在相應單元中。

- 調用預置廣播電臺：

短按相應的預置電臺數字鍵(1~6)，可收聽預存在此單元的廣播電臺。

手動調諧電臺頻率



在收音廣播模式，短按 >>I 或 I<< 鈕可步進遞增或遞減搜索電臺頻率。

自動調諧電臺頻率

在收音廣播模式，長按 >>I 或 I<< 鈕可遞增或遞減搜索強信號電臺頻率。

自動存儲預置廣播電臺

在收音廣播模式，長按AS鈕2秒以上，收音系統將自動存儲18個FM廣播電臺和12個AM(MW)廣播電臺。

按鍵	使用說明
RDS 開/關	輕輕按下音量按鈕，選擇“區域 歐洲”站。系統將在3秒內改變頻率設置。
PTV  (程序類型)	一旦進入PTY模式，長按  按鈕進入程序類型項目，並旋轉編碼器音量旋鈕到選定的類別。 ■ 可用程序類型： POP；搖滾樂；簡單；輕音樂；經典；其他；爵士樂；鄉村；民族；老歌；民間；測驗；警鐘；新聞；事件；信息；體育；教育；戲劇；文化；科學；多樣性；天氣；金融；兒童；社會；宗教；電話；旅遊；休閒；文件
AF (收音機頻道)	■ ON: 該單元將搜索另一個具有較強信號但具有與當前站自動相同的程序標識的站。 ■ OFF 關閉
TA (交通頻道)	■ ON: 當有交通堵塞時，單元切換到調諧器模式（不管當前模式如何），並開始廣播交通堵塞的情況。當交通堵塞結束時，它返回到迂回模式。 ■ OFF: 交通情況不通知

播放CD光碟和USB閃存設備內的音樂

插入CD光碟

將CD光碟(標準尺寸:直徑12cm)標籤面朝上插入主機碟倉。機子將自動播放插入CD光碟上的音樂。

退出CD光碟

短按主機面板上的出碟鈕(▲), CD光碟將從主機碟倉彈出。

USB閃存接口

想要播放USB閃存設備內的音樂,請將USB閃存插入本機面板的USB接口。閃存設備插入后,MP3/WMA或其他音樂文件將能自動播放。

注意:

此USB接口可為蘋果和安卓智能手機充電,充電電流為1A。

選擇播放下一首或上一首歌曲

在CD光碟或USB閃存播放模式,短按 >>| 或 |<< 鈕選擇播放下一首歌曲或上一首歌曲。

歌曲快進或歌曲快退

在CD光碟或USB閃存播放模式,長按 >>| 或 |<< 鈕實現快進或快退功能。

音樂播放/暫停播放

在CD光碟或USB閃存播放模式,短按 ▶/|| 鈕暫停播放音樂。再次短按此鈕繼續播放。

歌曲前10秒預覽

在CD光碟或USB閃存播放模式,短按INT鈕預覽每首歌曲的前10秒。再次短按此鈕取消歌曲10秒預覽功能。

- INT ON - 預覽每首歌曲的前10秒。
- INT OFF - 取消歌曲10秒預覽功能。

重復播放模式選擇

在CD光碟或USB閃存播放模式,短按RPT鈕選擇重復播放當前文件夾內所有歌曲,重復播放USB閃存內所有歌曲,或重復播放當前歌曲。

- RPT FLD - 反復播放當前文件夾內所有歌曲。
- RPT ALL - 播放USB閃存內所有歌曲。
- RPT ONE - 反復播放當前選中的歌曲。

隨機播放歌曲

在CD光碟或USB閃存播放模式,短按RDM鈕以隨機順序播放USB閃存內所有歌曲,再次短按此鈕取消隨機播放歌曲模式。

播放CD光碟和USB閃存設備內的音樂

- RDM ON - 以隨機順序播放USB閃存內所有歌曲。
- RDM OFF - 取消隨機播放模式。

選擇上一個或下一個文件夾/選擇上10首或下10首歌曲

- 在光碟或USB閃存播放模式，短按  或  鈕選擇上一個或下一個文件夾。只有當光碟USB閃存內有多個文件夾，才可進行此功能操作。
- 在光碟或USB閃存播放模式，長按  或  鈕選擇上10首歌曲或下10首歌曲。只有當光碟或USB閃存內有超過10首歌曲，才可進行此功能操作。

藍牙免提操作

藍牙配對和藍牙連接

首次使用此本機作為手機的藍牙免提系統前，用戶必須將按以下步驟將本機和手機進行藍牙配對和連接：

1. 在任意模式下，在藍牙配對和連接之前，本機顯示屏上的藍牙字符“BT”會一不停地閃爍，提醒用戶本機藍牙免提系統未與藍牙手機連接。本藍牙系統會持續向周圍發送藍牙配對信號，直到與周圍的藍牙設備配對連接成功。在藍牙配對之前，用戶需要將手機上的藍牙功能開啟。
2. 當藍牙手機搜索并檢測到本藍牙免提系統時，用戶可在手機屏幕的藍牙設備列表中發現“NQ821B”。
3. 用戶點按設備列表中的“NQ821B”可將藍牙手機與本機的藍牙免提系統進行配對連接。連接成功后，本機顯示屏上的藍牙字符“BT”會停止閃爍，持續點亮。
4. 配對連接完成后，手機的來電呼叫提示聲，通話語音，藍牙音樂都會自動轉移到本機藍牙免提系統上。

注意事項：有關更多詳細的藍牙配對操作，請參考藍牙手機的使用說明書。

撥打電話

需要撥打電話時，可直接通過配對連接的藍牙手機撥號并往外撥打。

重撥最後撥打過的電話號碼

長按面板上的  鈕重播最後撥打過(或最後接聽過)的電話號碼。

接聽來電

當有電話打進來時，來電號碼會滾動出現在本機顯示屏上，短按面板上的  鈕接通電話。

拒絕接聽來電

當有電話打進來不想接聽時，短按面板上的  鈕掛斷來電。

終止通話

通話過程中，長按面板上的  鈕終止通話。

選擇手機通話或藍牙免提通話

在通話過程中，短按面板上的  鈕可將通話語音在藍牙免提系統和藍牙手機之間相互切換。

藍牙免提系統

調節通話音量

- 通話過程中，旋轉面板上的音量鈕或短按遙控器上的音量鈕VOL+/VOL-可調節通話的音量大小。
- 通話過程中，短按面板上或遙控器上的靜音量鈕打開或關閉靜音功能。

藍牙音樂播放(A2DP)

本機支持通過A2DP無線流式音頻將藍牙手機上的音樂傳輸到此車載播放器進行播放。

用本機面板上的以下按鈕可控制藍牙手機上的音樂播放：

- 短按面板上的 >>I 鈕選擇播放藍牙手機上的下一首歌曲。
- 短按面板上的 I<< 鈕選擇播放藍牙手機上的上一首歌曲。
- 短按面板上的 ▶/II 鈕選擇播放或暫停播放藍牙手機上的歌曲。

通過手機APP控制主機音頻

使用此NAKAMICHI手機APP, 用戶可通過蘋果或安卓智能手機無線控制此NQ821B車載播放器的音頻。

請通過蘋果APP Store和谷歌Play Store搜索此NAKAMICHI手機APP，將APP下載到手機并安裝。



用戶將智能手機與此NQ821B車載播放器配對連接后，點按智能手機屏幕上的這款手機APP圖標開啟此手機APP。

這樣，用戶就可通過智能手機來控制此NQ821B車載播放機的音頻功能了。

備註：

如果用戶購買的主機帶有RDS功能(可選功能)，用戶還可通過此手機APP控制NQ821B車載播放器的RDS功能。

性能指標

基本指標

電源：	DC 12V
最大輸出功率：	50W X 4CH
喇叭阻抗：	4 - 8 Ohm
機身尺寸(寬x高x深)：	178 X 160 X 50 mm
機身重量：	1.3 kg
保險絲：	10 A

收音指標

FM

頻率範圍：	87.5 MHz - 107.9 MHz (美國頻率) 87.5 MHz - 108.0MHz (歐洲頻率)
調諧步進值：	200 KHz(美國頻率) 50 KHz(歐洲頻率)

AM(MW)

頻率範圍：	530 KHz - 1710 KHz (美國頻率) 522-1620 KHz(歐洲頻率)
調諧步進值：	10 KHz(美國頻率) 9 KHz(歐洲頻率)

CD/USB指標

適用音樂格式：	CD/MP3/WMA
USB接口類型：	2.0
USB充電輸出：	5V/1A
頻率響應：	20 Hz - 20KHz
信噪比：	60dB

藍牙指標

支持的藍牙配置文件格式：	A2DP, AVRCP, HFP
頻率範圍：	2.4GHz 頻譜

電源和揚聲器接線注意事項

切勿把揚聲器導線接頭接至電池，否則本機將會嚴重損壞。
在把揚聲器導線接頭接至揚聲器之前，檢查您汽車上的揚聲器線路。

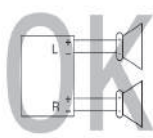
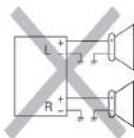
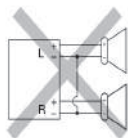

FCC WARNING

This device complies with Part 15 of the FCC Rules. Operation is subject to the following two conditions:

- (1) this device may not cause harmful interference,
- (2) this device must accept any interference received, including interference that may cause undesired operation.

Caution:

The user is cautioned that changes or modifications not expressly approved by the party responsible for compliance could void the user's authority to operate the equipment.

Note:

This equipment has been tested and found to comply with the limits for a Class B digital device, pursuant to part 15 of the FCC Rules. These limits are designed to provide reasonable protection against harmful interference in a residential installation. This equipment generates uses and can radiate radio frequency energy and, if not installed and used in accordance with the instructions, may cause harmful interference to radio communications. However, there is no guarantee that interference will not occur in a particular installation. If this equipment does cause harmful interference to radio or television reception, which can be determined by turning the equipment off and on, the user is encouraged to try to correct the interference by one or more of the following measures:

- Reorient or relocate the receiving antenna.
- Increase the separation between the equipment and receiver.
- Connect the equipment into an outlet on a circuit different from that to which the receiver is connected.
- Consult the dealer or an experienced radio/TV technician for help.



SCAN OUR QR CODE OR VISIT WWW.NAKAMICHICARAUDIO.COM
FOR COMPLETE AUDIO SETTINGS INSTRUCTIONS

 [nakamichi.global](https://www.facebook.com/nakamichi.global)  [nakamichi.caraudio](https://www.instagram.com/nakamichi.caraudio)

Made in China | 中國製造